

(DE) ACHTUNG!

Vor Beginn der Montagearbeiten lesen Sie bitte aufmerksam die Sicherheitshinweise!

(EN) WARNING!

Before assembling, please read carefully the safety instructions!

(NL) LET OP!

Lees de veiligheidsinstructies zorgvuldig door voordat u met de montage begint!

(FR) ATTENTION!

Avant le début des travaux de montage, prière de lire attentivement les consignes de sécurité

(IT) ATTENZIONE!

Prima di installare leggere attentamente l'avviso di sicurezza!

(ES) ATENCIÓN!

Antes de comenzar con los trabajos de montaje leer detenidamente los avisos de seguridad!

(PL) UWAGA!

Przed przystąpieniem do prac montażowych uważnie należy przeczytać wskazówki bezpieczeństwa!

(FI) HUOMIO!

Ennen asennustöiden aloittamista pyydämme Teitä lukemaan turvaohjeet huolellisesti!

(CZ) POZOR!

Než začnete provádět montážní práce, přečtěte si důkladně bezpečnostní pokyny!

(RU) ВНИМАНИЕ!

До начала монтажных работ внимательно прочтите эти указания по технике безопасности!

(GR) ΠΡΟΣΟΧΗ!

Πριν την διεξαγωγή της συναρμολόγησης διαβάστε προσεκτικά τις υποδείξεις ασφαλείας!

(RO) ATENȚIUNE!

A se citi cu atenție indicațiile privind siguranța, înainte de începerea montării!

(BG) ВНИМАНИЕ!

Преди Да Започнете работите по монтажа прочетете ВНИМАТЕЛНО упТВаниеТо За безопасност!

(TR) DİKKAT!

Montaja başlamadan önce güvenli talimatnamesini titizlikle okuyunuz!

(HU) FIGYELEM!

A szerelési munkák megkezdése előtt figyelmesen olvassa el a biztonsági útmutatásokat!

(SV) OBS!

Läs säkerhetsanvisningarna noga innan du börjar med monteringsarbetena!

(HR) POZOR!

Prije početka montaže molimo pozorno pročitajte sigurnosne naputke!

(SL) POZOR!

Prosim, da pred začetkom montaze, zaradi varnosti preberete vas navodila, ki so priložena!

(SK) POZOR!

Pred tým ako začnete robiť montážne práce, prečítajte si dôkladne bezpečnostné pokyny!

(PT) CUIDADO!

Antes de iniciar os trabalhos de montagem por favor leia atentamente os avisos de segurança!

(BA) POZOR!

Prije početka montaže molimo pažljivo pročitajte sigurnosne upute!

(LT) DĖMESIO!

Norėdami saugiai ir teisingai sumontuoti šviestuv vadovaukitės šia instrukcija!

(ET) HOIATUS!

Enne monteerimist lugege ohutusjuhised tähelepanelikult läbi!

(DA) OBS!

Læs sikkerhedsinformationen nøje, før du monterer produktet!

(NO) ADVARSEL!

Les sikkerhetsinformasjonen nøye før du monterer produktet!

(LV) UZMANĪBU!

Pirms montāžas uzmanīgi izlasiet drošības norādījumus!



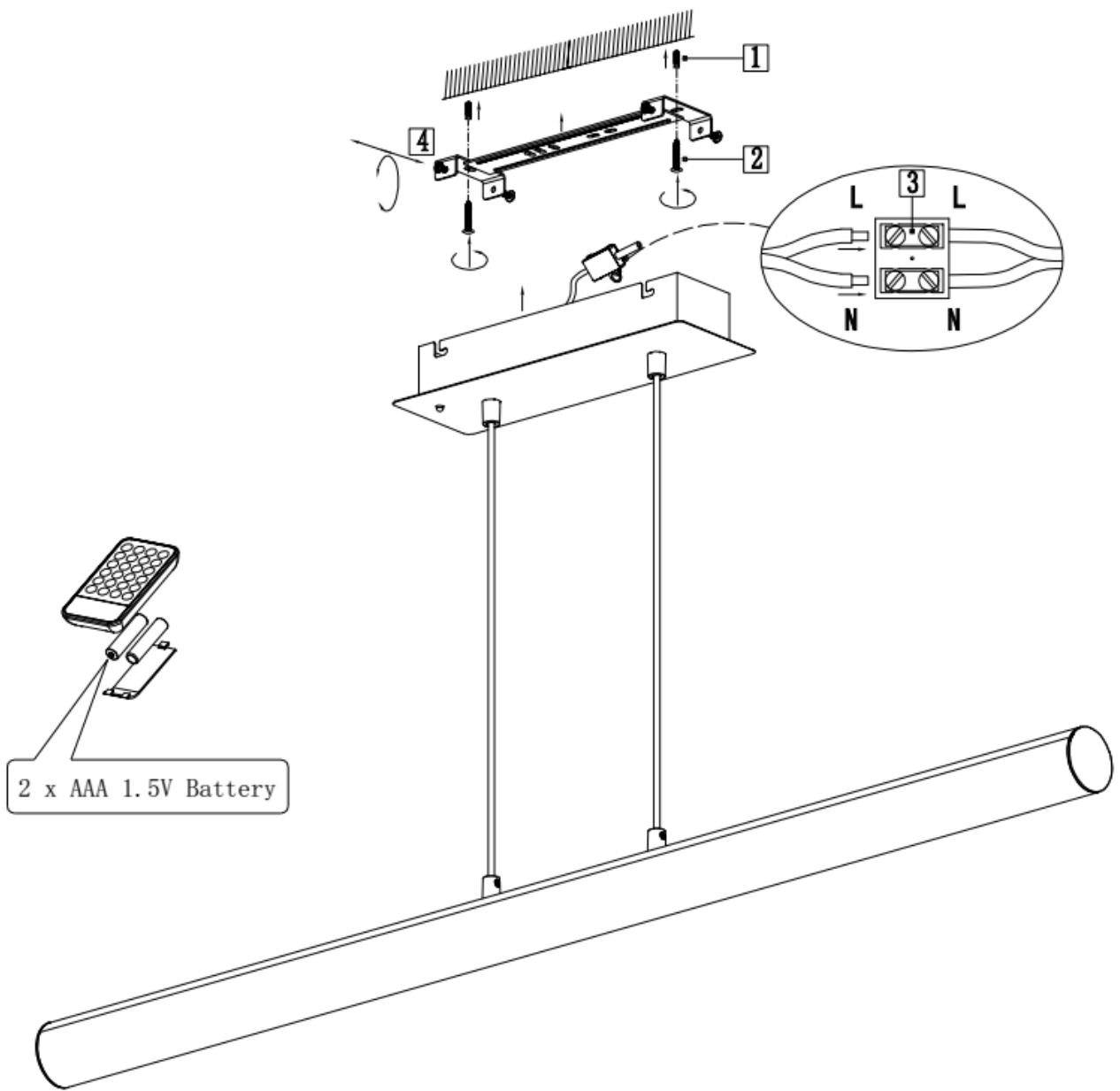





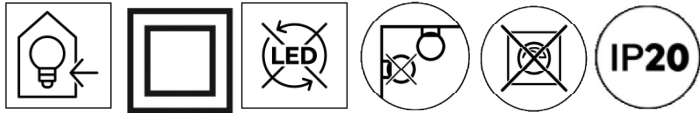

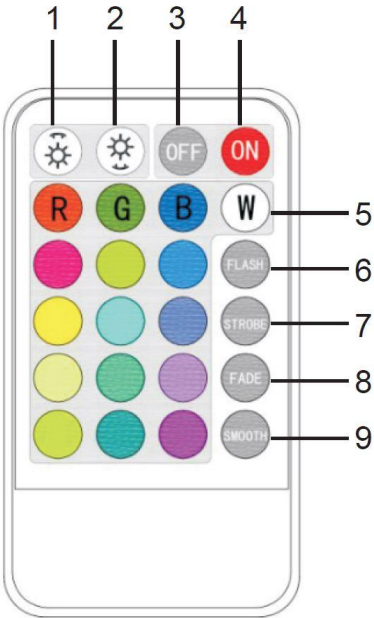

2 x AAA 1.5V Battery









230V ~ 50Hz
1 x LED 10W

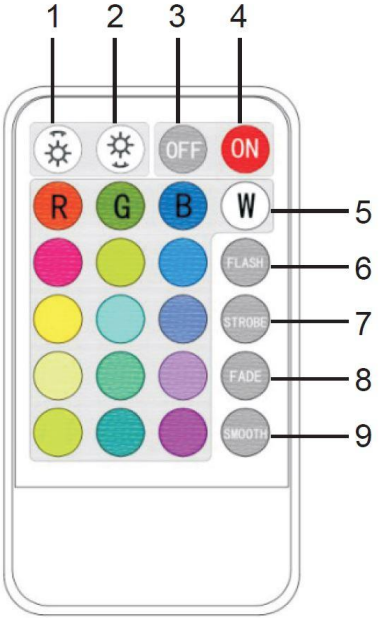







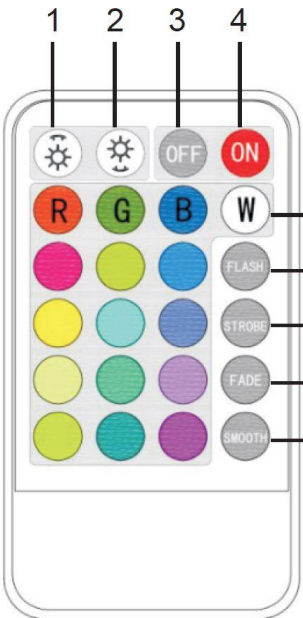

Funktionsweise der Fernbedienung

1		Helligkeit erhöhen	
2		Helligkeit reduzieren	
3		Gerät ausschalten	
4		Gerät einschalten	
5		Direktauswahl von 16 Farben beim Drücken der jeweiligen Tasten.	
6		Farbmodus «FLASH»	
7		Farbmodus «STROBE»	
8		Farbmodus «FADE»	
9		Farbmodus «SMOOTH»	







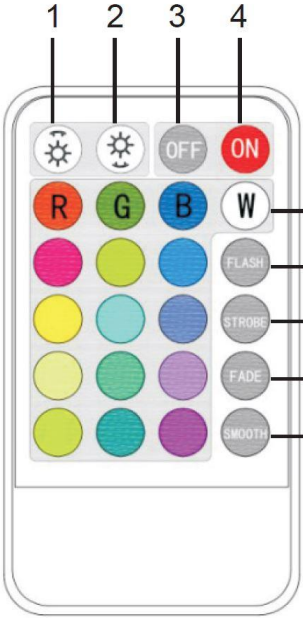

Operation with the remote control

1		Increase brightness	
2		Reduce brightness	
3		Switch the lamp off	
4		Switch the lamp on	
5		16 colors can be selected directly by pressing a button	
6		Color mode «FLASH»	
7		Color mode «STROBE»	
8		Color mode «FADE»	
9		Color mode «SMOOTH»	



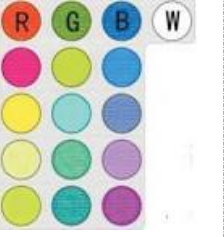



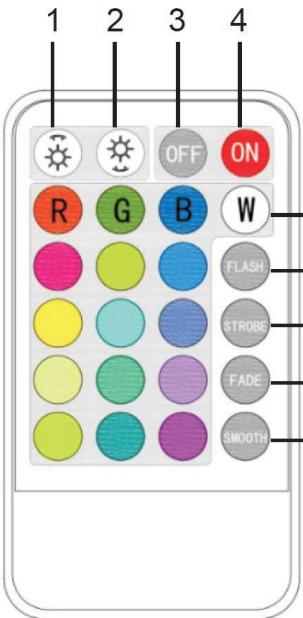

Operación con el control remote

1		Aumenta el brillo	
2		Reduce el brillo	
3		Apaga la lámpara	
4		Enciende la lámpara	
5		Selección inmediata de 16 colores al pulsar el botón correspondiente	
6		Modo de color «FLASH»	
7		Modo de color «STROBE»	
8		Modo de color «FADE»	
9		Modo de color «SMOOTH»	







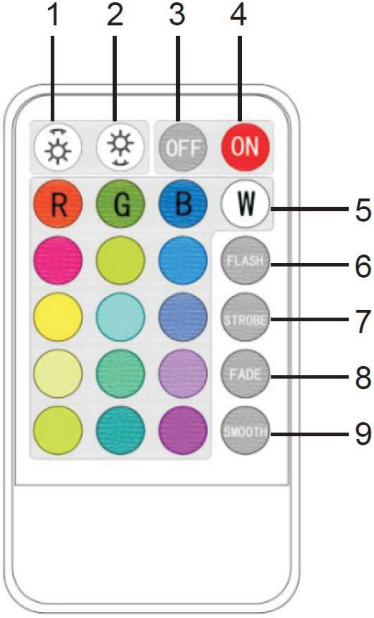

Funzionamento con il telecomando

1		Aumenta la luminosità	
2		Riduci la luminosità	
3		Spegni la lampada	
4		Accendi la lampada	
5		Selezione diretta di 16 colori premendo il relativo pulsante	
6		Modalità colore «FLASH»	
7		Modalità colore «STROBE»	
8		Modalità colore «FADE»	
9		Modalità colore «SMOOTH»	







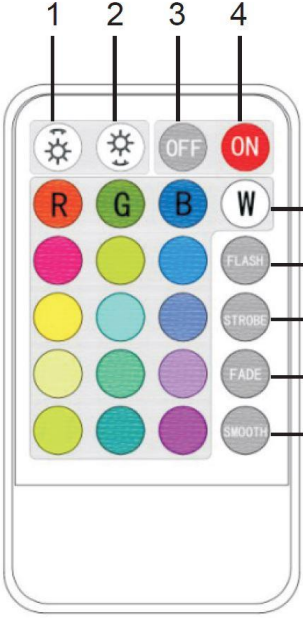

Fonctionnement avec la télécommande

1		Augmentez la luminosité	
2		Réduisez la luminosité	
3		Éteignez la lampe	
4		Allumez la lampe	
5		Sélectionnez directement 16 couleurs en appuyant sur le bouton correspondant	
6		Mode couleur «FLASH»	
7		Mode couleur «STROBE»	
8		Mode couleur «FADE»	
9		Mode couleur «SMOOTH»	







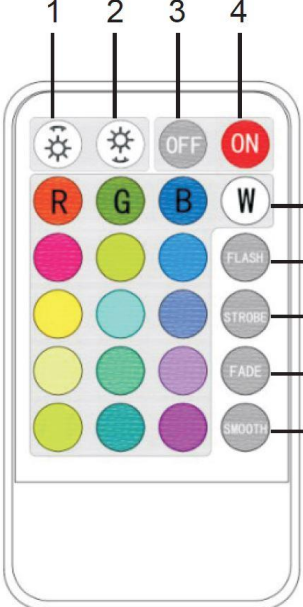

Работа с дистанционното управление

1		Увеличаване на яркостта	
2		Намаляване на яркостта	
3		Изключване на лампата	
4		Включване на лампата	
5		Директен избор на 16 цвята чрез натискане на съответния бутон	
6		Цветови режим «FLASH»	
7		Цветови режим «STROBE»	
8		Цветови режим «FADE»	
9		Цветови режим «SMOOTH»	







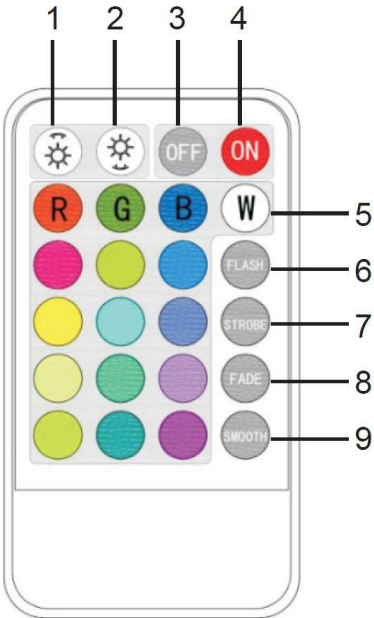

Rukovanje daljinskim upravljačem

1		Povećajte osvijetljenost	
2		Smanjite osvijetljenost	
3		Isključite lampu	
4		Uključite lampu	
5		Direktan izbor 16 boja pritiskom na odgovarajuće dugme	
6		Režim boje «FLASH»	
7		Režim boje «STROBE»	
8		Režim boje «FADE»	
9		Režim boje «SMOOTH»	







Operace s dálkovým ovládáním

1		Zvýšit jas	
2		Snížit jas	
3		Vypnout svítilnu	
4		Zapnout svítilnu	
5		Vyberte si z 16 barev stisknutím příslušného tlačítka	
6		Barevný režim «FLASH»	
7		Barevný režim «STROBE»	
8		Barevný režim «FADE»	
9		Barevný režim «SMOOTH»	

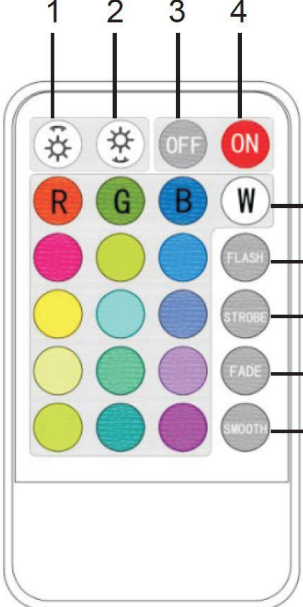





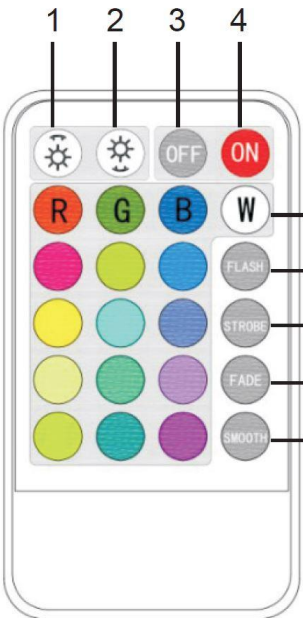

Betjening med fjernbetjeningen

1		Skru op for lysstyrke	
2		Skru ned for lysstyrke	
3		Sluk for lampen	
4		Tænd for lampen	
5		Direkte valg af 16 farver ved at trykke på den tilhørende knap	
6		Farvetilstand «FLASH»	
7		Farvetilstand «STROBE»	
8		Farvetilstand «FADE»	
9		Farvetilstand «SMOOTH»	







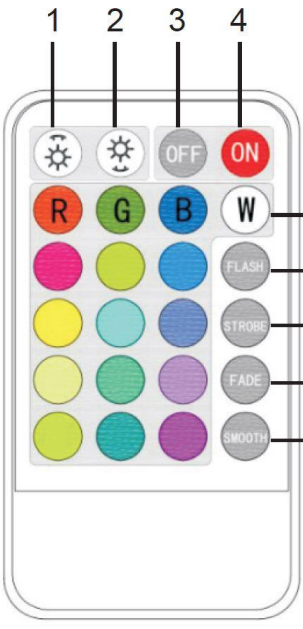

Λειτουργία με το τηλεχειριστήριο

1		Αύξηση φωτεινότητας	
2		Μείωση φωτεινότητας	
3		Απενεργοποίηση λάμπας	
4		Ενεργοποίηση λάμπας	
5		Άμεση επιλογή 16 χρωμάτων με το πάτημα του σχετικού κουμπιού	
6		Λειτουργία χρώματος «FLASH»	
7		Λειτουργία χρώματος «STROBE»	
8		Λειτουργία χρώματος «FADE»	
9		Λειτουργία χρώματος «SMOOTH»	



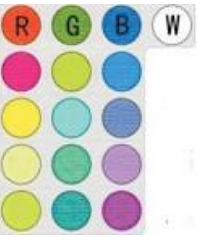



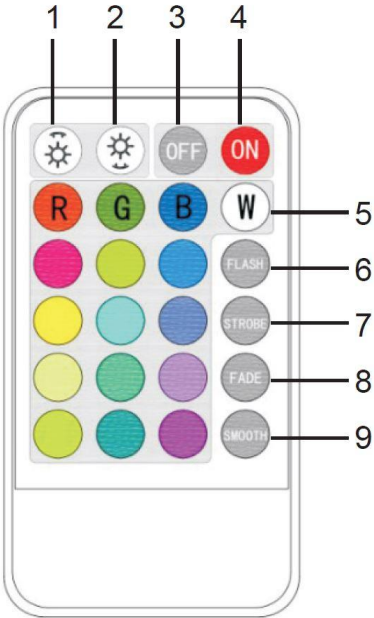

Kaugjuhtimisseadme käsitsemine

1		Suurendage heledust	
2		Vähendage heledust	
3		Lülitage lamp välja	
4		Lülitage lamp sisse	
5		16 värvi otsene valik, vajutades sellega seotud nupule	
6		Värvirežiim «FLASH»	
7		Värvirežiim «STROBE»	
8		Värvirežiim «FADE»	
9		Värvirežiim «SMOOTH»	







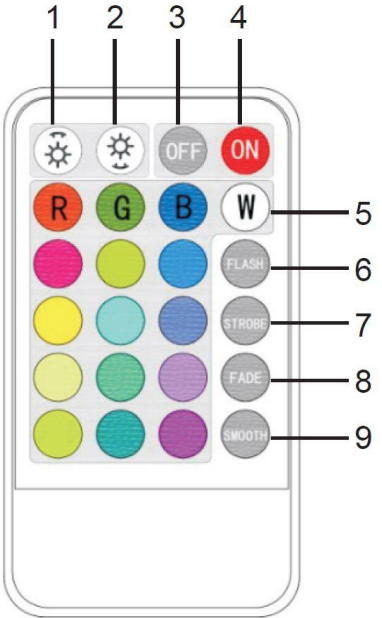

Käyttö kaukosäätimellä

1		Lisää kirkkautta	
2		Vähennä kirkkautta	
3		Kytke valaisin pois päältä	
4		Kytke valaisin päälle	
5		Suora 16 värin valinta painikkeilla	
6		Väritila «FLASH»	
7		Väritila «STROBE»	
8		Väritila «FADE»	
9		Väritila «SMOOTH»	







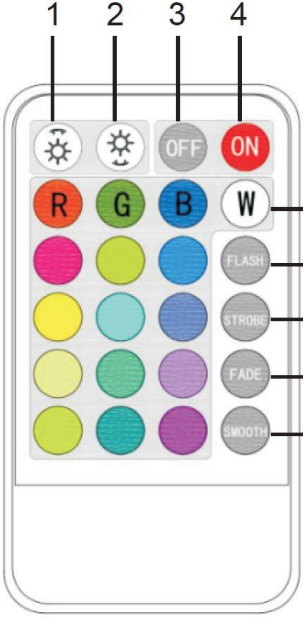

Upravljanje daljinskim upravljačem

1		Povećaj svjetlinu	
2		Smanji svjetlinu	
3		Ugasi lampu	
4		Upali lampu	
5		Izravan odabir 16 boja pritiskom na odgovarajući gumb	
6		Način rada u boji «FLASH»	
7		Način rada u boji «STROBE»	
8		Način rada u boji «FADE»	
9		Način rada u boji «SMOOTH»	







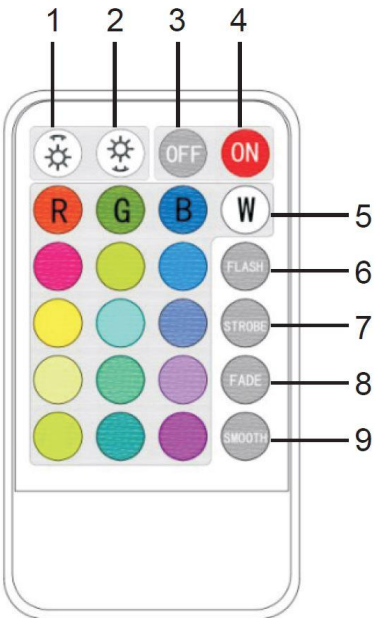

Kezelés a távvezérlővel

1		Fényerő növelése	
2		Fényerő csökkentése	
3		Lámpa lekapcsolása	
4		Lámpa felkapcsolása	
5		Közvetlen választás a 16 szín közül a megfelelő gomb megnyomásával	
6		«FLASH» színmód	
7		«STROBE» színmód	
8		«FADE» színmód	
9		«SMOOTH» színmód	







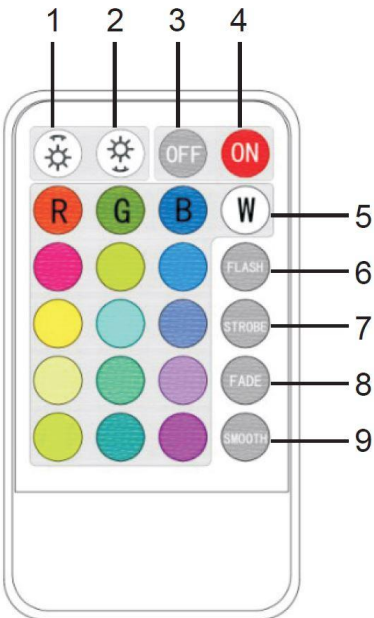

Oreguliavimas nuotolinio valdymo pulteliu

1		Ryškumo padidinimas	
2		Ryškumo sumažinimas	
3		Lempos išjungimas	
4		Lempos įjungimas	
5		Pasirinkimas tiesiogiai iš 16 spalvų, paspaudus atitinkamą mygtuką	
6		Spalvos režimas «FLASH» (žybsėjimas)	
7		Spalvos režimas «STROBE» (blyksėjimas)	
8		Spalvos režimas «FADE» (laipsniškas ryškumo mažėjimas)	
9		Spalvos režimas «SMOOTH» (tolygumas)	







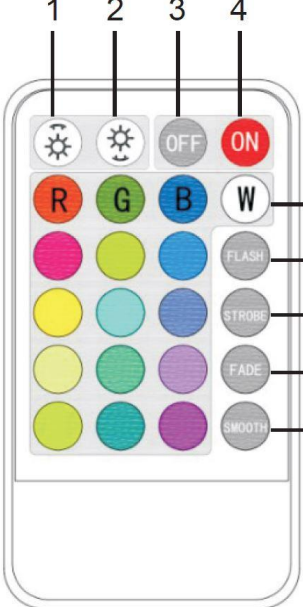

Lietošana, izmantojot tālvadības pulti

1		Palielināt spilgtumu	
2		Samazināt spilgtumu	
3		Izslēgt lampu	
4		Ieslēgt lampu	
5		Tieša 16 krāsu izvēle, nospiežot attiecīgo pogu	
6		Krāsu režīms «FLASH»	
7		Krāsu režīms «STROBE»	
8		Krāsu režīms «FADE»	
9		Krāsu režīms «SMOOTH»	



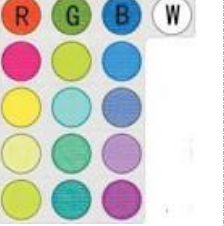



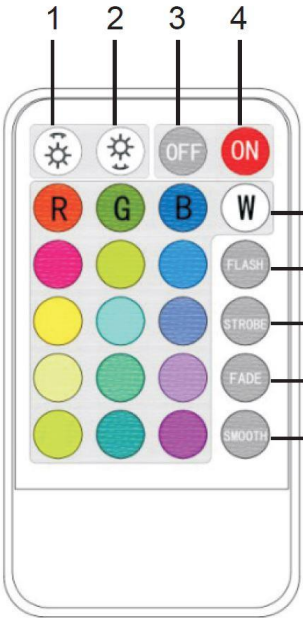

Bediening met de afstandbediening

1		Helderheid verhogen	
2		Helderheid verlagen	
3		De lamp uitzetten	
4		De lamp aanzetten	
5		Directe selectie van 16 kleuren door op de overeenkomstige toets te drukken	
6		Kleurmodus «FLASH»	
7		Kleurmodus «STROBE»	
8		Kleurmodus «FADE»	
9		Kleurmodus «SMOOTH»	







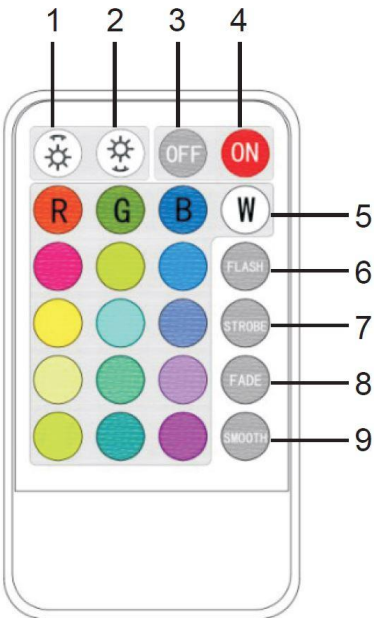

Drift med fjernkontrollen

1		Øk lysstyrke	
2		Reduser lysstyrke	
3		Slå av lampen	
4		Slå på lampen	
5		Direkte valg av 16 farger ved å trykke på relatert knapp	
6		Fargemodus «FLASH»	
7		Fargemodus «STROBE»	
8		Fargemodus «FADE»	
9		Fargemodus «SMOOTH»	







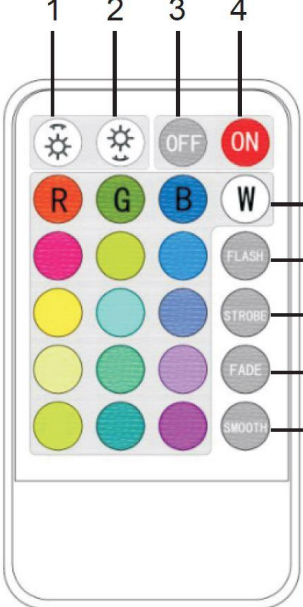

Obsługa pilotem zdalnego sterowania

1		Zwiększanie jasności	
2		Zmniejszanie jasności	
3		Wyłączanie lampy	
4		Włączanie lampy	
5		Bezpośredni wybór 16 kolorów poprzez naciśnięcie odpowiedniego przycisku	
6		Tryb koloru «FLASH»	
7		Tryb koloru «STROBE»	
8		Tryb koloru «FADE»	
9		Tryb koloru «SMOOTH»	







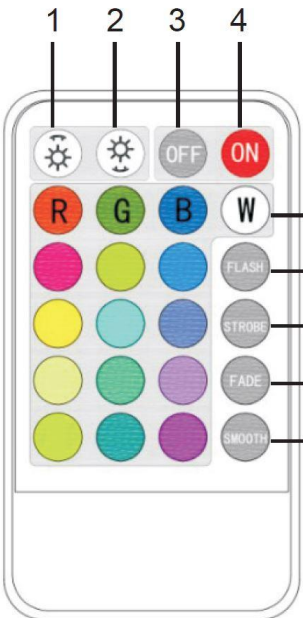

Utilização com o controlo remote

1		Aumentar a luminosidade	
2		Diminuir a luminosidade	
3		Desligar a lâmpada	
4		Ligar a lâmpada	
5		É possível seleccionar diretamente 16 cores premindo o botão correspondente	
6		Modo de cor «FLASH»	
7		Modo de cor «STROBE»	
8		Modo de cor «FADE»	
9		Modo de cor «SMOOTH»	







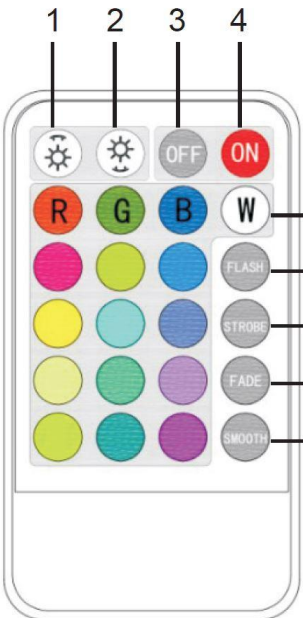

Utilizarea telecomenzii

1		Creștere luminozitatea	
2		Micșorare luminozitatea	
3		Pornire lumină	
4		Oprire lumină	
5		Selectare directă a 16 culori prin apăsarea butonului corespunzător	
6		Mod culoare «FLASH»	
7		Mod culoare «STROBE»	
8		Mod culoare «FADE»	
9		Mod culoare «SMOOTH»	







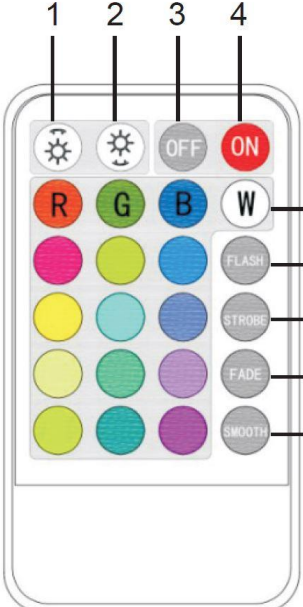

Работа под дистанционным управлением

1		Увеличить яркость	
2		Уменьшить яркость	
3		Выключить лампу	
4		Включить лампу	
5		Непосредственный выбор 16 цветов нажатием соответствующей кнопки	
6		Цветовой режим «FLASH»	
7		Цветовой режим «STROBE»	
8		Цветовой режим «FADE»	
9		Цветовой режим «SMOOTH»	







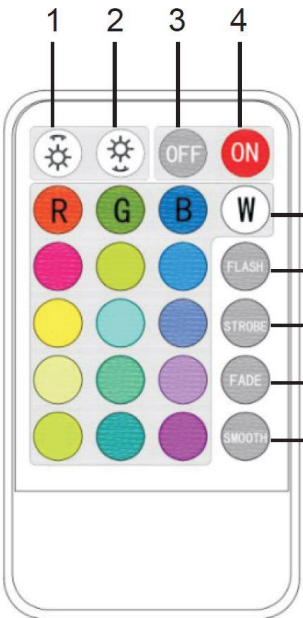

Obsluha pomocou diaľkového ovládania

1		Zvýšenie jasú	
2		Zníženie jasú	
3		Vypnutie lampy	
4		Zapnutie lampy	
5		Priamy výber 16 farieb stlačením príslušného tlačidla	
6		Režim farby «FLASH»	
7		Režim farby «STROBE»	
8		Režim farby «FADE»	
9		Režim farby «SMOOTH»	



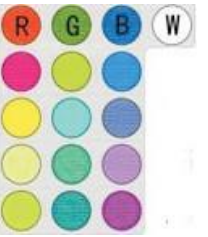



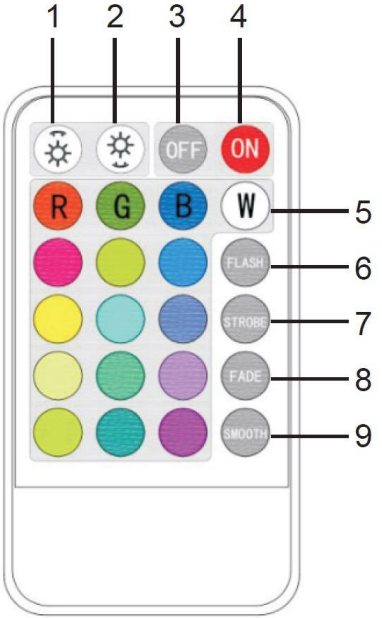

Upravljanje z daljinskim upravljalnikom

1		Povečajte svetlost	
2		Zmanjšajte svetlost	
3		Izklopite žarnico	
4		Vklopite žarnico	
5		Neposredna izbira 16 barv s pritiskom ustreznega gumba	
6		Barvni način «FLASH»	
7		Barvni način «STROBE»	
8		Barvni način «FADE»	
9		Barvni način «SMOOTH»	

Funktioner med fjärrkontrollen

1		Öka ljusstyrkan	
2		Minska ljusstyrkan	
3		Släcka lampan	
4		Tända lampan	
5		Direkt val av 16 färger genom att trycka på avsedd knapp	
6		Färgläge «FLASH»	
7		Färgläge «STROBE»	
8		Färgläge «FADE»	
9		Färgläge «SMOOTH»	

Uzaktan Kumanda ile Çalıştırma

1		Parlaklığı artır	
2		Parlaklığı azalt	
3		Lambayı kapat	
4		Lambayı aç	
5		İlgili düğmeye basılarak doğrudan 16 renk seçimi	
6		«FLASH» Renk modu	
7		«STROBE» Renk modu	
8		«FADE» Renk modu	
9		«SMOOTH» Renk modu	